

FMT

Medical Sensors, Cables and Accessories



DIAGNOSTIC EKG CABLES & ACCESSORIES

REV.41 0702.2023



E1-- / XXXY / Z

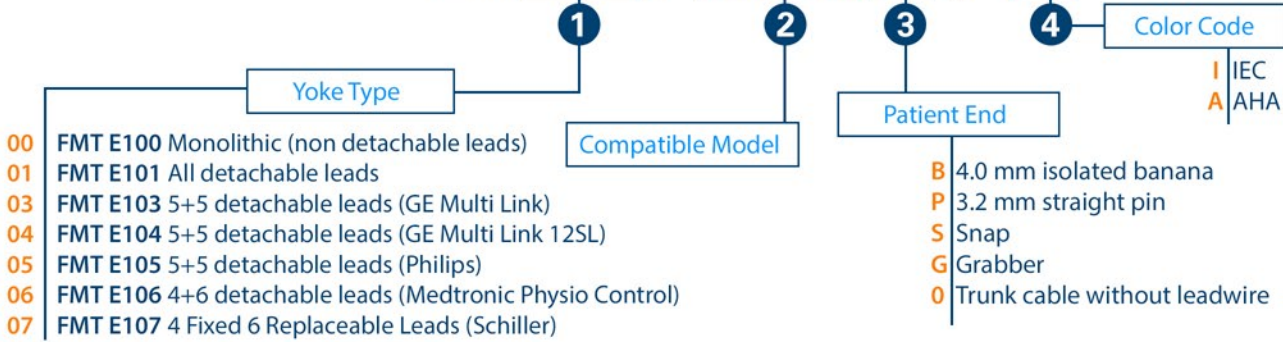

To determine the part code enter specified parameter values instead of X.

1 FMT Diagnostic EKG cables are monolithic or with replaceable leads compatible with various trunk cable types for different EKG devices. Available options may be determined from "Yoke Types" section.

Full part number is valid for trunk cable and grouped leads. If you would like to buy the trunk cable without leads, just write "0" value for patient end -field 4-, after filling other sections.

2 You can find cables for various brands and models, resistor values in "Compatible Models" section.

3 4 Patient end connections can be selected from banana, straight pin, grabber or snap options. You can choose Patient End code and IEC or AHA color code from "Leadwires Patient Ends" section.

EKG Cables have 1.80 m trunk cable length (Ø6.0 mm), 80 cm chest and 100 cm extremity lead lengths (Ø3.0 mm). Other lengths are available upon request.

Yoke Types

• E100 type yoke



One piece 10 lead (non detachable leads).

• E101 type yoke



10 lead (all detachable leads)

• E103 type yoke



10 lead (5+5 detachable leads), GE MULTI-LINK type yoke.

• E104 type yoke



10 lead (5+5 detachable leads), GE MULTI-LINK 12SL type yoke.

• E105 type yoke



10 lead (5+5 detachable leads), PHILIPS type yoke.

• E106 type yoke



10 lead (4+6 detachable leads), Medtronic/Physio Control type yoke.

• E107 type yoke



10 lead (4+6 detachable leads), Schiller type yoke.

Diagnostic EKG Cables & Accessories

Compatible Brands & Models

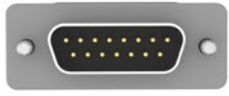

15 pin D-sub connector with screws

E100/DNY/Z
E101/DNY/Z

E100/DRY/Z
E101/DRY/Z

10 kΩ

Philips/HP M1770A(Pagewriter 200i-300i), M1771A (Pagewriter 200), M1772A (Pagewriter 100), Cable OEM M3703C. **Bionet** All Models. **BTL** All Models. **Aspel** All Models. **Innomed** All Models. **Mortara** ELI150, ELI210, ELI250, ELI350.

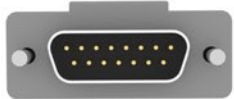

15 pin D-sub connector with screws

E100/SRY/Z
E101/SRY/Z

10 kΩ

Schiller AT, AT1, AT2, AT3, AT5, AT6, AT10, AT60, A104 PC, CS100, CS6, CS6/12, AT101, AT102, AT104. **Esaote** P80, P120. **Kontron** P80.

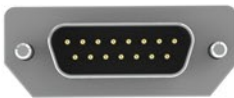

15 pin D-sub connector with screws

E100/NNY/Z
E101/NNY/Z

E100/NRY/Z
E101/NRY/Z

10 kΩ

Nihon Kohden Cardiofax C6151, 6353, 8270, 8350, 8370, 8420, 8423, 8450, 8453, 8820, 8823, 8830, 9620, 9010, 9020, 9022, 9110, 9130, 9132. **Dong Jiang** All Models. **Biocare** All Models. **Cardioline** AR600, AR1200, ELAN, ELAN1100, Cardiette Excel 103, 106, 112, 212, Deadalus Models, Microruler & Autoruler Models.



15 pin D-sub connector

E100/GRY/Z
E101/GRY/Z
E103/GRY/Z

10 kΩ

GE Microsmart, MAC500 MAC1000, MAC1100, MAC1200ST, MAC400, MAC600, MAC800, MAC1600.

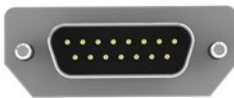

15 pin D-sub connector with screws

E100/ERY/Z
E101/ERY/Z

10 kΩ

Edan SE-1200 Express, SE-12, SE-12 Express, SE-601, SE-3, SE-1. **Mindray** DECG-03A.



16 pin circular connector

E100/CRY/Z
E101/CRY/Z

4.7 kΩ

Cardioline Delta 1, 3, 30, 60, Delta 1 plus, Delta 3 plus, Delta 60 plus. **Suzuken Kenz** 103, 106.



15 pin D-sub connector with latch on the top

E100/KRY/Z
E101/KRY/Z

10 kΩ

Fukuda ME KP-5000.



15 pin D-sub connector with 45 degree angle and locking plastic latches

E100/HRY/Z
E101/HRY/Z

10 kΩ

Bosch 603D, 603ER, 603S, 606. **Customed**, **Hellige** EK36, EK41, EK43, EK53, EK56, EK403, 413, 512, E512P, Cardiosmart, Cardiosys. **Siemens** Sicard 440/440S, 460/460S, 740, Sicard 803, Sirecust 701, Cathcor, Cardiostat 1,3T, 703, 710, Cardinex 3T, 4, 6T, 703, 710, Megacard Elema A13, R, R/E, Miracard1. **Hörmann** Bioset9000.



15 pin D-sub connector with locking metal latches

E100/FNY/Z
E101/FNY/Z

-

E100/FRY/Z
E101/FRY/Z

10 kΩ

Fukuda Denshi Autocardiner, Cardiomax, FX2111, FX7411, FX7402, FX7202, FX2155, FX3010, FX7102.

Diagnostic EKG Cables & Accessories

Compatible Brands & Models



E100/MRY/Z
E101/MRY/Z

10 kΩ

Mortara ELI 50, ELI 100, ELI 200.

15 pin D-sub connector with locking plastic latches



E100/LNY/Z
E101/LNY/Z

-

PETAŞ Kardiopet 300, 500.

12 pin circular connector

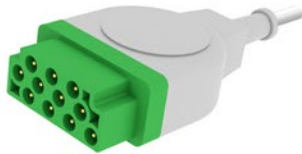
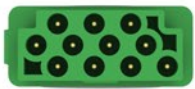

E100/BNY/Z
E101/BNY/Z
E104/BNY/Z

-

GE Solar 7000/8000/9500, DASH 2500, 3000, 4000, 5000, Eagle 500, 1000, 3000, 5000, BP30, Dinamap PRO 1000, MAC-Lab, Tram Modules.

11 pin rectangular connector

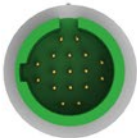

E100/TRY/Z
E101/TRY/Z

1 kΩ

Spacelabs Ultraview 90496.

17 pin circular connector



E100/YRY/Z
E101/YRY/Z

10 kΩ

Fukuda Denshi DS7300.

12 pin circular connector



E100/ZRY/Z

10 kΩ

TEPA All Stress Modules.

Only Grabber and Snap options are available.

15 pin DB15 female connector with screws



E100/JRY/Z
E101/JRY/Z

10 kΩ

Burdick Eclipse, 4, 8, 400, 800, LE11, 850, 8501, Eclipse Plus, ATRIA, ATRIA PLUS, ATRIA 3000.

15 pin D-sub connector



E100/ARY/Z
E101/ARY/Z

4.7 kΩ

Trismed All Models.

15 pin D-sub connector with screws



E100/ONY/Z
E101/ONY/Z

-

Carewell ECG1101, 1103, 1106, 1112, T10, T12.

15 pin D-sub connector with screws

Diagnostic EKG Cables & Accessories

Compatible Brands & Models



12 pin circular connector



E100/RRY/Z 10 kΩ
E106/RRY/Z

Medtronic Physio Control Lifepak 12/20.
Only Grabber and Snap options are available.



12 pin circular connector



E100/PRY/Z 1-3.2 kΩ
E105/PRY/Z

Philips / HP M1949A.
Only Grabber and Snap options are available.



12 pin circular connector



E100/IRY/Z 10 kΩ

Progetti Rescue Life Defibrillator.
Only Grabber and Snap options are available.



15 pin connector



E100/WRY/Z 10 kΩ
E107/WRY/Z

Zoll M Series.
Only Grabber and Snap options are available.

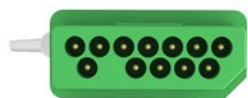

12 pin rectangular connector



E100/QNY/Z -

Nihon Kohden TEC-8300K Series Defibrillator.
Only Grabber and Snap options are available.



13 pin circular connector



E100/VRY/Z 1 kΩ

Metrax Primedic Defimonitor EVO, **Mediana** D500.
Only Grabber and Snap options are available.



13 pin circular connector



E107/URG/Z 1 kΩ

Schiller Argus Pro Lifecare 2, Defigard Touch 7, Physiogard Touch 7
Only Grabber option is available.

Diagnostic EKG Cables & Accessories

Leadwires

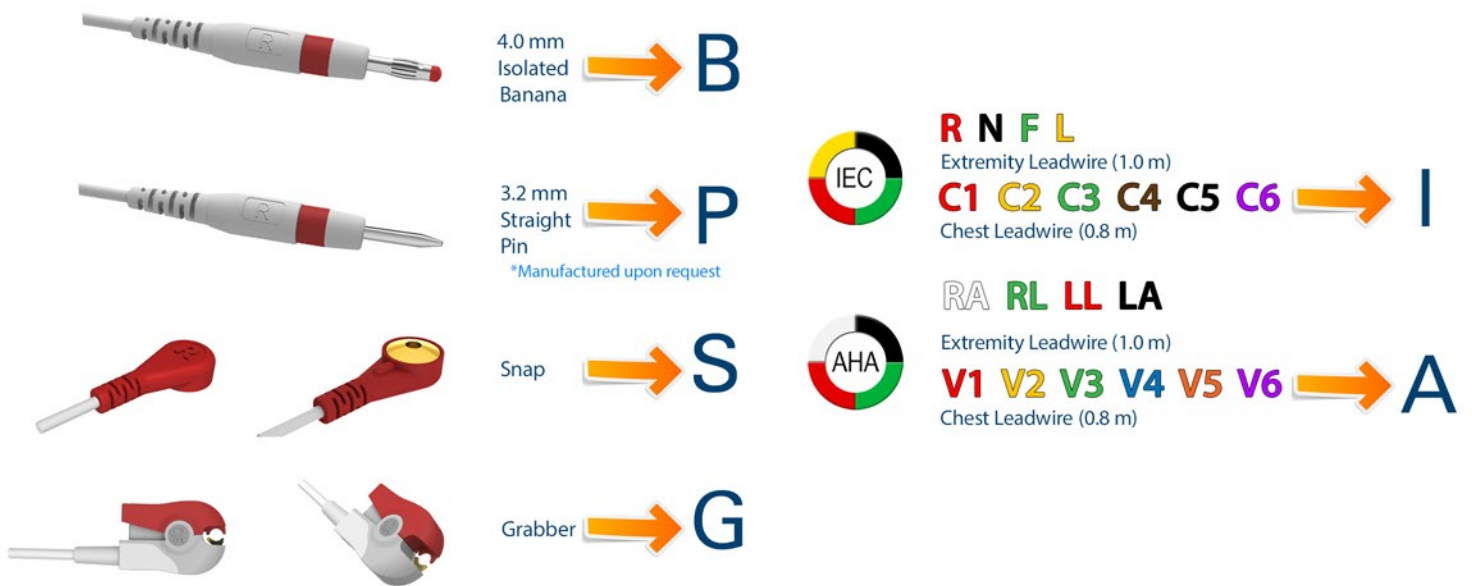

• "B" for 4.0 mm isolated banana, "P" for 3.2 mm straight pin, "S" for snap, "G" for grabber, "I" for IEC color coding, "A" for AHA color coding.

Replacement Leadwires

■ You can determine the part number using the below table to order as a set. A Special Indicator is used to distinguish some grouped leadwire sets consisting of different leadwire combinations. Please see the relevant pictures.

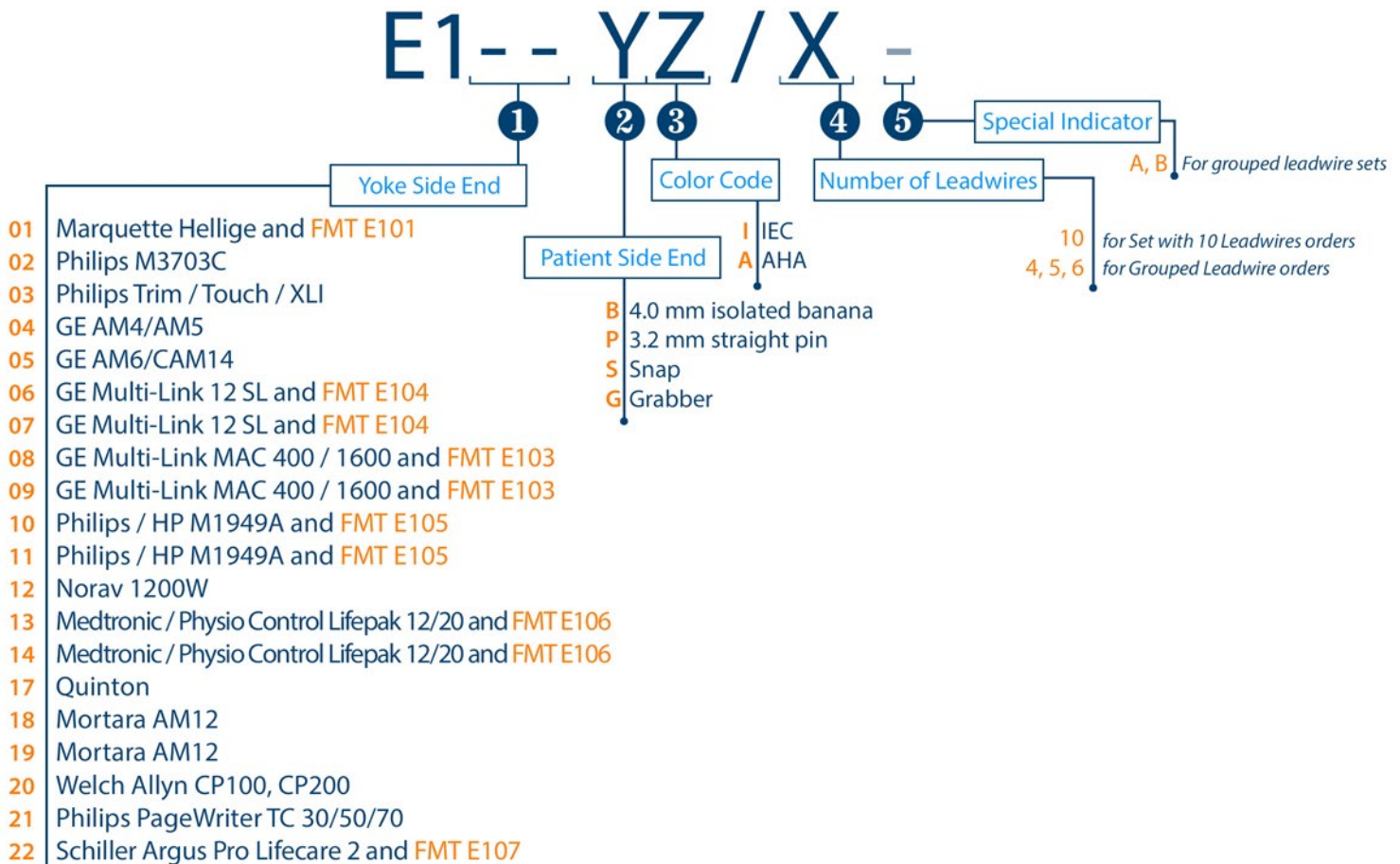

Diagnostic EKG Cables & Accessories

Leadwires

- **E101YZ/10** Leadwire for **Marquette Hellige** and **FMT E101** cable yokes. (R/N/F/L 110 cm, C1/C2/C3/C4/C5/C6 80 cm)



Example:
E101BI/R leadwire
with banana end,
IEC color code, R

- **E102YZ/10** Leadwire for **Philips M3703C** EKG Module. (R/N/F/L 110 cm, C1/C2/C3/C4/C5/C6 80 cm)



Example:
E102BI/R leadwire
with banana end,
IEC color code, R

- **E103YZ/10** Leadwire for **Philips PageWriter Trim/Touch/XLI** EKG Module. (R/N/F/L 110 cm, C1/C2/C3/C4/C5/C6 80 cm)



Example:
E103BI/R leadwire
with banana end,
IEC color code, R

- **E104YZ/10** Leadwire for **GE AM4/AM5** EKG Module. (R/N/F/L 110 cm, C1/C2/C3/C4/C5/C6 80 cm)



Example:
E104BI/R leadwire
with banana end,
IEC color code, R

- **E105YZ/10** Leadwire for **GE AM6/CAM14** Module and **FMT E103** cable yoke. (R/N/F/L 110 cm, C1/C2/C3/C4/C5/C6 80 cm)



Example:
E105BI/R leadwire
with banana end,
IEC color code, R

- **E106YZ/5** Grouped Leadwire for **GE Multi-Link 12 SL** and **FMT E104** cable yokes. (R/N/F/L/C 100 cm)



Example:
E106SI/5 Leadwire
set with 5 snap end,
IEC color code, (N,R,L,F,C)

- **E107YZ/5** Grouped Leadwire for **GE Multi-Link 12 SL** and **FMT E104** cable yokes. (C2/C3/C4/C5/C6 100 cm)



Example:
E107SI/5 Leadwire
set with 5 snap end,
IEC color code, (C2,C3,C4,C5,C6)

- **E108YZ/5** Grouped Leadwire for **GE Multi-Link MAC 400 / 1600** and **FMT E103** cable yokes. (N/R 110cm, C1/C2/C3 80cm)



Example:
E108SI/5 leadwire set
with 5 snap end,
IEC color code, (N,R,C1,C2,C3)

- **E109YZ/5** Grouped Leadwire for **GE Multi-Link MAC 400 / 1600** and **FMT E103** cable yokes. (L/F 110cm, C4/C5/C6 80cm)



Example:
E109SI/5 leadwire set
with 5 snap end,
IEC color code, (C4, C5, C6, L, F)

Diagnostic EKG Cables & Accessories

Leadwires

- **E110GZ/5-OR** Grouped Leadwire with ESU protection for **Philips/HP M1668A, M1663A, M1949A** and **FMT E105** cable yokes. (C/R/L/ 100cm, F/N 160cm) *Only Grabber option is available.*



Example:
E110GI/5-OR leadwire with
5 grabber end, IEC Color Code
(N, L, F, R, C/C1)

- **E111GZ/5-OR** Grouped Leadwire with ESU protection for **Philips/HP M1663A, M1949A** and **FMT E105** cable yokes. (C6/C5/C4/C3/C2 100cm)
Only Grabber option is available.



Example:
E111GI/5-OR leadwire with ,
5 grabber end, IEC Color Code,
(C6, C5, C4, C3, C2)

- **E110YZ/5** Grouped Leadwire for **Philips/HP M1663A, M1949A** and **FMT E105** cable yokes. (C1/R/F/L/N 100cm)



Example:
E110SI/5 leadwire with
5 snap end, IEC color code,
(C1, R, F, L, N)

- **E111YZ/5** Grouped Leadwire for **Philips/HP M1663A, M1949A** and **FMT E105** cable yokes. (C6/C5/C4/C3/C2 100cm)



Example:
E111SI/5 leadwire with
5 snap end, IEC color code,
(C6, C5, C4, C3, C2)

- **E112YZ/10** Leadwire for **Norav 1200W Module**. (R/L/N/F 110cm, C1/C2/C3/C4/C5/C6 80cm)
Only Grabber and Snap options are available.



Example:
E112GI/R leadwire with
grabber end, IEC color code, R

- **E113YZ/4** Grouped Leadwire for **Medtronic / Physio Control Lifepak 12/20** and **FMT E106** cable yokes. (F/L/R/N 100cm)



Example:
E113GI/4 leadwire with
4 grabber end, IEC color code,
(F, L, R, N)

- **E114YZ/6** Grouped Leadwire for **Medtronic / Physio Control Lifepak 12/20** and **FMT E106** cable yokes. (C1/C2/C3/C4/C5/C6 100cm)



Example:
E114GI/6 leadwire with
6 grabber end, IEC color code,
(C1, C2, C3, C4, C5, C6)

- **E117YZ/10** Leadwire for **Quinton stress test module**. (R/L/N/F 110cm, C1/C2/C3/C4/C5/C6 80cm)
Only Grabber and Snap options are available.



Example:
E117GI/R leadwire with
grabber end, IEC color code, R

Diagnostic EKG Cables & Accessories

Leadwires

- **E118YZ/10** Leadwire for **Mortara** AM12 and WAM EKG module. (N/R/L/F 120cm, C1/C2/C3/C4/C5/C6 90cm)

Only Banana and Grabber options are available.



- E118BI/5A(N, R, C1, C2, C3)
- E118BA/5A(RL, RA, V1, V2, V3)



- E118BI/5B (C4, C5, C6, L, F)
- E118BA/5B (V4, V5, V6, LA, LL)

Example:
E118BI/10 leadwire with banana end, IEC color code, (N, R, C1, C2, C3, C4, C5, C6, L, F)

- **E119GZ/10** Leadwire for **Mortara** AM12 and WAM Stress EKG module. (N/R/L 75cm, C1/C2 70cm, C3/C4/C5/C6 60cm, F 43cm)

Only Grabber option is available.



- E119GI/5A(N, R, C1, C2, C3)
- E119GA/5A(RL, RA, V1, V2, V3)

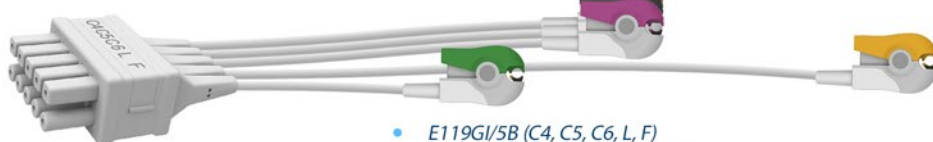

- E119GI/5B (C4, C5, C6, L, F)
- E119GA/5B (V4, V5, V6, LA, LL)

Example:
E119GI/10 leadwire with grabber end, IEC color code, (N, R, C1, C2, C3, C4, C5, C6, L, F)

- **E120YZ/10** Leadwire for **Welch Allyn** CP100, CP200 patient cable. (R/L/N/F 110cm, C1/C2/C3/C4/C5/C6 80cm)



Example:
E120BI/R leadwire with banana end, IEC color code, R

- **E121BZ/10** Leadwire for **Philips** PageWriter, TC 30/50/70. (N/R/L/F 100 cm, C1/C2/C3/C4/C5/C6 70cm)

Only Banana option is available.



- E121BI/3A(C1, C2, C3)
- E121BA/3A(V1,V2,V3)



- E121BI/3B (C4, C5, C6)
- E121BA/3B(V4, V5, V6)

Example:
E121BI/10 leadwire with banana end, IEC color code



- E120BI/R, E120BI/F, E120BI/L, E120BI/N
- E120BA/RA, E120BA/LL, E120BA/LA, E120BA/RL

- **E122GZ/6** Leadwire for **Schiller** Argus Pro Lifecare 2 and **FMT E107** (C1/C2/C3/C4/C5/C6 40cm)

Only Grabber option is available.



Example:
E122GI/6 leadwire with grabber end, IEC color code

Clamp Electrodes

- Universal connection is suitable for use with 3.2 mm straight pin, 4.0 mm banana or snap lead termination leadwires.
- All of the metallic surfaces are Silver–Silver Chloride (Ag/AgCl) plated to provide maximum signal quality.
- Color coded IEC or AHA protocols.
- The lengths of clamp electrodes are 140 mm for adult size, 89 mm for pediatric size.
- Supplied in package of 4 pieces set.

Adult	IEC	CEA11	Package 4 pcs./set, Red, Green, Yellow, Black
Adult	AHA	CEAA1	Package 4 pcs./set, Red, Green, White, Black
Pediatric	IEC	CEA12	Package 4 pcs./set, Red, Green, Yellow, Black
Pediatric	AHA	CEAA2	Package 4 pcs./set, Red, Green, White, Black



Suction Chest Electrode

- Suction chest electrodes with universal connection, are suitable for use with 3.2 mm straight pin, 4.0 mm banana or snap lead termination leadwires.
- All of the metallic surfaces are Silver–Silver Chloride (Ag/AgCl) plated to provide maximum signal quality.
- The outer diameter of adult suction bowl is 24.0 mm. The diameter of the silicone bulb is 30.0 mm. The diameter of pediatric suction bowl is 17.0 mm. The diameter of the silicone bulb is 21.4 mm.
- Supplied in package of 6 pieces set.

Adult	SE1	Package 6 pcs./set
Pediatric	SE2	Package 6 pcs./set

Banana to Snap Adaptor

- Banana to Snap Adaptors allows you to easily connect 3.2 mm straight pin and 4.0 mm banana plug leadwires to disposable ECG electrodes with 4.0 mm snap studs.
- Banana to Snap Adaptors supplied in package of 10 pieces set.



- **BS3** 3.2 mm straight pin to snap adaptor, Grey, Package 10 pcs./set
- **BS4** 4.0 mm banana to snap adaptor, White, Package 10 pcs./set

Banana to Alligator Clip Adaptor

- Allows you to easily connect 4.0 mm banana plug leadwires to disposable ECG electrodes with tab connectors.
- Supplied in package of 10 pieces set.

BA4 4.0 mm banana to alligator adaptor, 10 pcs./set



Banana to Grabber Adaptor

- Converts 3.2 mm straight pin and 4.0 mm banana plug leadwires to disposable ECG electrodes with 4.0 mm snap studs.
- Supplied in package of 10 pieces set.

BG3I/10	3.2 mm straight pin to grabber adaptor, Grey, IEC color code, Package	10 pcs./set
BG3A/10	3.2 mm straight pin to grabber adaptor, Grey, AHA color code, Package	10 pcs./set
BG4/10	4.0 mm banana to grabber adaptor, White, Package	10 pcs./set



FMT is registered trademark of **Metko Ltd.**



Headquarter & Factory

İvedik O.S.B. Ağaç İşleri Sanayi Sit.
1354. Cad. 1358.Sok. No:9
06378 Yenimahalle

ANKARA / TÜRKİYE

Tel (pbx) : +90 312 387 12 46
Fax : +90 312 387 12 51

Branch

Atatürk Mah. Sedef Cad. 38.Ada
Ata Plaza 3-5 Blokları Kat:2 No:57
34758 Ataşehir

İSTANBUL / TÜRKİYE

Tel (pbx) : +90 216 455 91 21
Fax : +90 216 455 48 24

www.metkold.com

Other products, logos and company names mentioned herein may be trademarks of their respective owners and are not to be taken as an endorsement of affiliation with FMT®. The information in this catalogue has been carefully checked and it is believed to be accurate. Images in this catalogue are representative of items offered. Actual product may have slight visual differences. In the interest of continued product development, Metko reserves the right to make changes and improvements to this catalogue and the product it described any time, without notice or obligation.